

350 FLUEBOOST

flueboost 350 • gas fire model



The flueboost is a box shaped unit with in line spigots for the flue connection, a pressure switch to ensure safe operation and plug-in electrical fittings for easy connection, all within a compact package.

H E L P L I N E

01565 755599

350

FLUEBOOST 350

Flueboost Installation and Technical Specification



GAS FIRE MODEL

ADVANTAGES OF AN INLINE FAN

- The ideal solution for listed buildings
- No need for scaffolding/cherry picker to install or for service/repairs
- Easy to maintain
- Acoustic surround available to reduce noise levels
- Can be located in loft/roof void/chimney stack so not an eyesore
- Not open to the elements giving a longer lifespan

CAPACITY AND RANGES

It will handle flue gases at up to 300 Deg.C dependant on size and length of flue. The fan is suitable for fireplaces with a maximum constructional opening of 0.5m². Ideally the flue gas velocity should be between 2.5 – 4 m/s. Please contact Flueboost prior to purchase to confirm the recommended duct diameter most suitable for the installation.

MOTOR

The motor is variable speed and has an centrifugal rotor with secondary cooling impeller, Class F windings and maintenance free sealed ball bearings with adequate lubrication to ensure reliable operation for many years.

CONNECTIONS

A plug-in electrical connector is supplied. This is multi-pin fitted with a six core number coded lead.

- Cable No.1: Grey – N/O Cable No.2: Black – N/C
 Cable No.3: Red – Common Cable No.4: Brown – Motor Live
 Cable No.5: Blue – Neutral Earth: Green/Yellow

PRESSURE SWITCH

The unit features an approved fail-safe function (Gas Appliance Directive 2009/142/EC) which will cut off the gas supply in the event of fan failure or flue blockage.

INSTALLATION AND MAINTENANCE

The unit can be fitted horizontally or vertically and located in a ceiling or roof void which allows easy access for maintenance.

FINISH

The unit is constructed from mill finish grade 304 stainless steel.

ELECTRICAL DETAILS

230 Volt; Single Phase; 115watt.
 Starting current 1.0 Amp.
 Running current 0.44 Amp.

WEIGHT

11.6 Kg.

Note: Please contact Flueboost if the unit is being installed with a sealed appliance.

FLUEBOOST HELPLINE

01565 755599

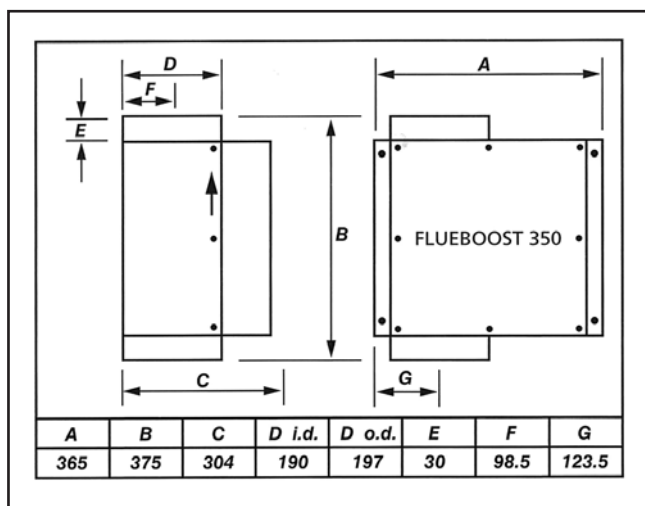
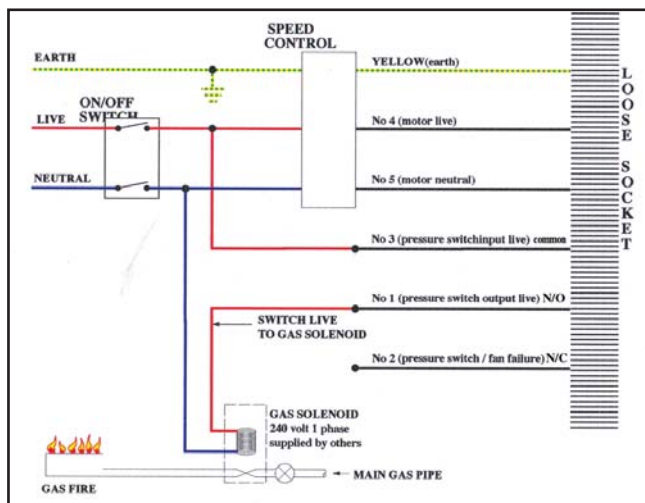
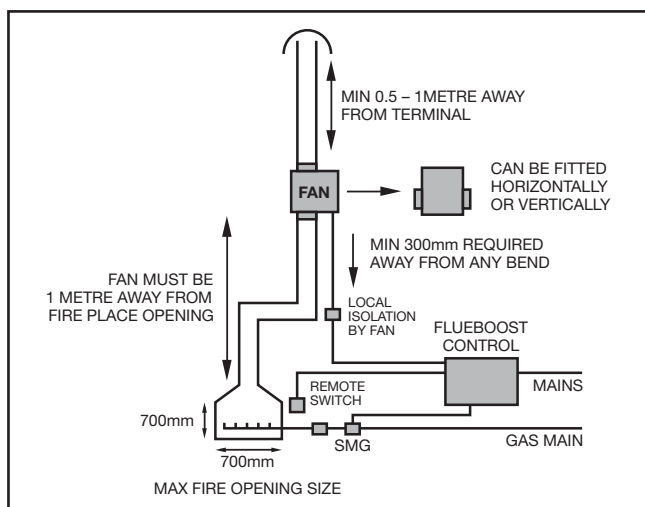



Model: FB350 Gas Fire Fan



Original Document



H E L P L I N E

01565 755599

Model: FB350 Gas Fire Fan

DESCRIPTION

The flueboost is a box shaped centrifugal fan unit within inline spigots for the flue connection, a pressure switch to ensure safe operation, and plug-in electrical fittings for easy connection all within a compact package.

FLUEBOOST 350 GAS FIRE UNIT SPECIFICATION

Maximum operating temperature

Flue gas temperature 300 Deg C

Ambient air temperature 40 Deg C

Electrical details

Supply 230V / 1Ph / 50Hz

Supply lead – 2 metre x 0.75mm, type YY x 6 core flex

FAN MOTOR

115 watt

Starting current – 1 Amp

Running current – 0.44 Amp

Motor speed 2600 R.P.M.

Flue spigot details

197 mm O.D.

Construction

Case – 304 grade stainless steel

Weight

11.6 Kg

DISCHARGE NOISE SOUND POWER MEASUREMENTS, dBa re 1pW

HIGH SPEED

Power Level	Frequency (Hz)									dBa / M
	63	125	250	500	1K	2K	4K	8K	Lw	
	62.5	65	69.5	74.4	67	64.9	63	53.7	77.2	53dBa /3M NR49
Pressure level at 3M	42	44.6	48.6	53.4	46.6	44.4	42.6	33.3		
	-26	-16	-9	-3	0	+1	+1	-1		
	16	28.6	39.6	50.4	46.6	45.4	43.6	32.3		
	1.6	2.9	4.0	5.0	4.7	4.5	4.4	3.2		
Pressure level at 10M	31.6	34.1	38.6	43.5	36.1	34	32.1	22.8		44dBa//10M NR39
	-26	-16	-9	-3	0	+1	+1	-1		
	5.6	18.1	29.8	40.5	36.1	35	33.1	21.8		
	0.6	1.8	3.0	4.1	3.6	3.5	3.3	2.2		

LOW SPEED

Power Level	Frequency (Hz)									dBa / M
	63	125	250	500	1K	2K	4K	8K	Lw	
	53.5	56.1	62.6	59.1	54.7	52.6	49.3	36.0	65.8	43dBa /3M NR35
Pressure level at 3M	33	36.7	42.2	38.7	34.26	32.16	28.9	15.56		
	-26	-16	-9	-3	0	+1	+1	-1		
	16	20.7	33.2	35.7	34.26	33.16	29.9	14.56		
	1.6	2.1	3.3	3.6	3.4	3.3	3.0	1.5		
Pressure level at 10M	31.6	25.2	31.7	28.2	23.8	21.7	18.4	5.1		30dBa//10M NR25
	-26	-16	-9	-3	0	+1	+1	-1		
	5.6	9.2	22.7	25.2	23.8	22.7	19.4	4.1		
	0.6	0.9	2.3	2.5	2.4	2.3	1.9	0.4		

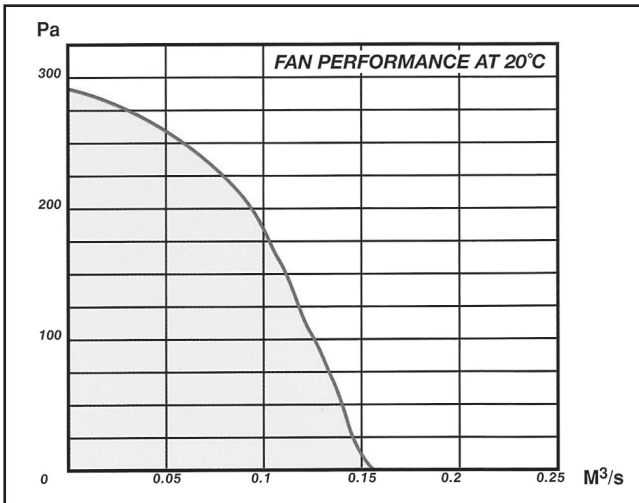

ELECTRICAL INSTALLATION

It is strongly recommended that all electrical installation work is carried out by a qualified electrician and that all wiring must conform to the relevant codes of practice and IEE Regulations. Mains supply must be 230V / 1Ph / 50Hz

The Flueboost unit must be correctly earthed – a double pole fused (5Amp class F) isolating switch must be incorporated into the basic wiring circuit.

Note: In all installations it is essential that the Flueboost is connected in the supply circuit between the appliance controls and the gas valve, so in the event of fan failure the gas valve will remain shut.

Safety

Ensure, before switching on, that no parts have been removed and that all screws are tight. Failure to check might result in a safety hazard. Operation on the mains supply other than that stated might result in damage to the fan components and produce a hazardous situation.

Materials and Fire Characteristics

The materials employed in the manufacture of these fans do not constitute a fire hazard. A correctly installed fan is not subject to self-ignition. The terminal block, motor winding and wiring may give off a small quantity of toxic fumes in the event of a fire source external to the fan. The materials used in these components are all self-extinguishing. The majority of the unit utilises non-combustible materials.

UNIT WIRING

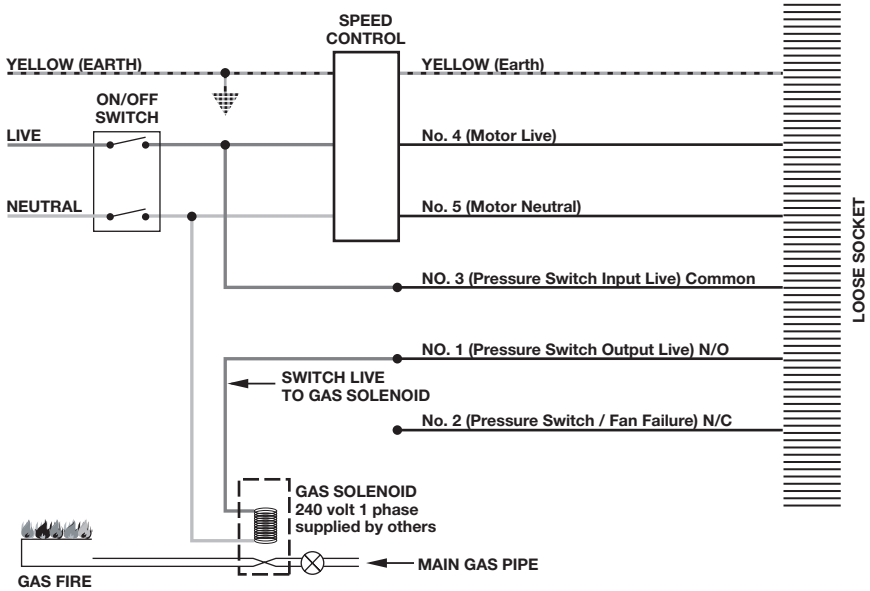

INSTALLATION

- Loft
- Chimney stack/chimney breast
- Ceiling void

Please ensure there is adequate circulation of air around the fan for cooling – see minimum clearance recommendations.

The fan should be mounted as per detailed instructions. Any other method of mounting must be approved by Flueboost in writing.

The Flueboost fan may be positioned in the primary flue (please see figure 1 on page 6) but must have a draft stabiliser/diverter on the system.

The flue pipe size must be selected so velocity is less than 4 m/s.

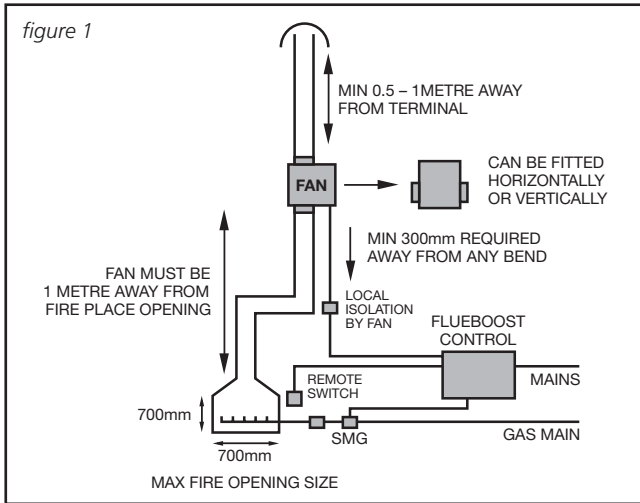

The front cover must be on a vertical plane or on top but never be facing down.

The front cover must never be placed against a wall; the fan requires an access panel for routine maintenance. Please follow the minimum clearance guidelines illustrated on page 7.

The Flueboost requires air to circulate & cool itself down so please ensure this is established prior to installation.

The Flueboost is for 230V/ 1Ph /50Hz appliances only.

Air must be allowed to pass through the fan on start up.

The direction of flow is indicated on the side of the fan in the form of an arrow.

Should another fan be in the same room as the unit please contact Flueboost prior to installation as it may affect performance.

When fitting the Flueboost into the flue, the gap between the spigot and the flue duct should be caulked with a suitable material, i.e. fire cement, high temperature silicone sealant.

The fan is to be installed internally only (not external), and must never come into contact with liquid.

MINIMUM CLEARANCE RECOMMENDATIONS

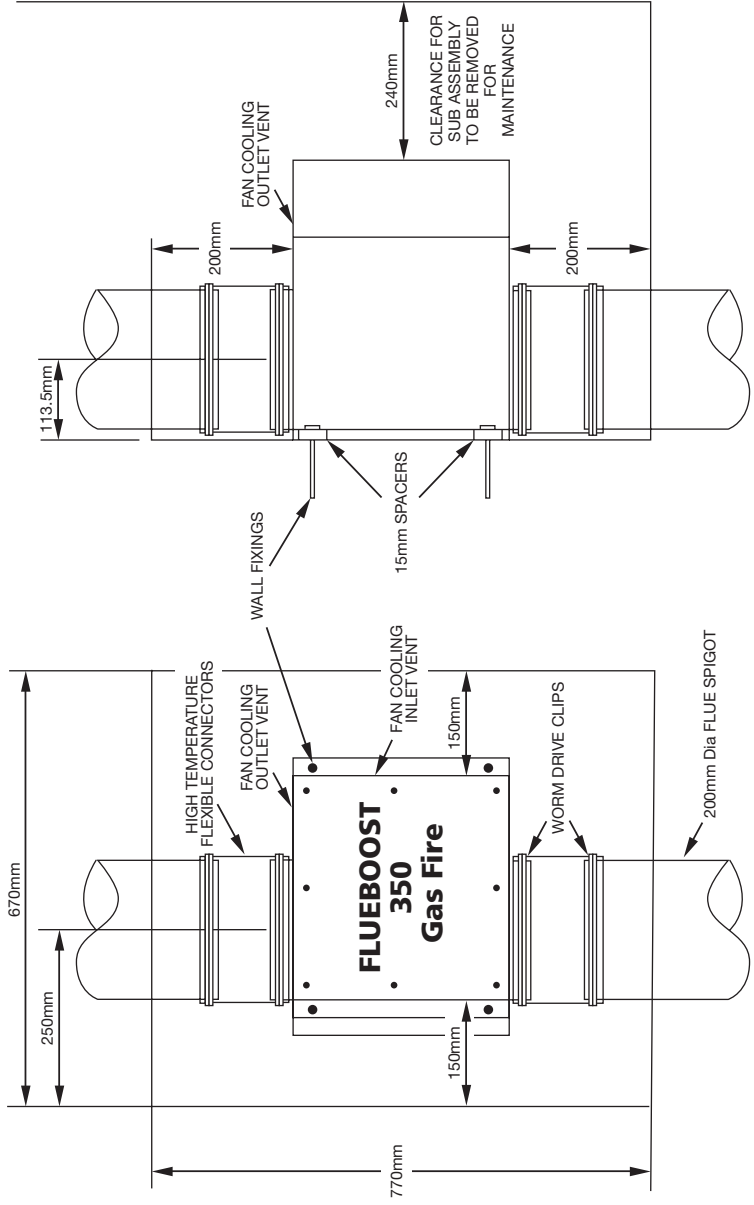

MAINTENANCE

No special attention is required. The fan is pre-oiled and has sealed for life bearings to ensure reliable operation of the Flueboost for many years.

At the same time, the opportunity should be taken to remove dust or foreign matter on and around both the unit cooling and main impellers. These operations can be effected as follows.

- Isolate the Flueboost unit from the mains electric supply.
- Remove the front cover via 8 x M6 screws.
- Release the 12 x M6 screws securing the controls tray to the flue box, the controls tray may now be withdrawn.
- The cooling impeller may now be cleaned with a light brush or an air compressor.
- Check the pressure switch for satisfactory operation.
- Re-assemble the Flueboost and reconnect to the mains electric supply.
- In the event of a fan failure, isolate from the mains electric supply before attempting to identify the cause.

Note

The Flueboost is designed so that it is not necessary to remove the main flue box from the flue ducting for either repair or maintenance. All working parts may be removed via the controls tray as a sub assembly.

WARNING

Never remove the front cover without first disconnecting the mains electric supply.

This fan must never be exposed to liquids. If a liquid accidentally splashes over the fan immediately disconnect the fan from the mains electric supply, clean and dry thoroughly before reconnecting.

COMMISSIONING

The fan must only be commissioned by a fully qualified gas safe engineer.

SAFETY INFORMATION

1. Inspection of goods upon receipt

Check the information on the fan case label and ensure that the goods are compatible with your requirements, inspect for any sign of damage including internal i.e. parts may have broken free and report any damage immediately to the supplier – do not install or use a damaged fan.

2. Storage

Store in a dry clean environment.

3. Handling

When handling the fan never allow its weight to bear on the cable or electrical fittings.

4. Safe use

Do not use the fan in an environment containing flammable or corrosive gasses or dust. The fan must be fitted within the flue system so that the impellers are guarded i.e. not accessible.

Ensure, before switching the flue fan on, that no parts have been removed and that all screws etc. are tight - failure to do so might result in a safety hazard.

Operating the fan on an electrical supply other than 230V / 1Ph / 50Hz will damage the fan and produce a hazardous situation.

In the event of a fan failure, isolate the fan from the mains electric supply before attempting to identify the cause; this is of particular importance due to the fan having rotating parts within the controls tray. The fan must never be exposed to liquids. If a liquid accidentally spills over the fan, disconnect the fan from the mains electric supply, clean and thoroughly dry before inspecting. After satisfactory inspection of both the fan and installation, then it may be considered operational, providing the health and safety requirements are met; as specified within the Machinery Directive 89/392 and current revisions.

5. Supply voltage

230V / 1Ph / 50Hz

6. Material content

The materials employed in the manufacture of this fan do not constitute a hazard.

7. Fire characteristics

A correctly installed fan is not subject to self-ignition. The terminal block, wiring loom and motor may give off a small quantity of toxic fumes in the event of a fire external to the fan. The materials used for these components are self-extinguishing

8. Disposal

No special hazards are envisaged. Do not dispose of by incineration.

RETURNS POLICY

If the product is not no longer required and returned to us within 14 days of purchase in the original packaging then we will offer a full refund – less a 20% re-stocking charge (subject to inspection of the goods).

Any goods returned after this time will considered on an individual basis and only a credit against a future purchase will be offered.

GUARANTEE

Flueboost Ltd guarantees its products for two years from the date of purchase against faulty materials or workmanship. In the event of any part being found defective the product will be repaired, or at the companies discretion replaced, without charge, providing the product:

- Has been installed and used in accordance with the instructions provided with each unit.
- Has not been connected to an unsuitable electric supply.
- Has not been subject to misuse, neglect or damage.
- Has not been modified or repaired by any person not authorised by the company.

If Claiming Under Terms of Guarantee

Please return the complete product, carriage paid by your original supplier or to Flueboost Ltd, ensuring it is adequately packed and accompanied by a letter clearly marked **GUARANTEE CLAIM** stating the nature of the fault and evidence of the date and source of purchase.

This guarantee is offered as a benefit, and does not affect your legal rights.

Consequential Claims

May we remind you that our guarantee covers replacement or repair by ourselves of the goods agreed by us as faulty. It does not include reimbursement of costs incurred unless specifically agreed in advance in writing. Agreement of this type can only be authorised from the appropriate person at Flueboost Ltd, no one else is authorised to alter or modify our terms of guarantee.



Unit 6 The Grove
Parkgate Industrial Estate
Knutsford
Cheshire WA16 8XP

T: 01565 755 599

F: 01565 755 055

E: info@flueboost.co.uk

www.flueboost.co.uk